

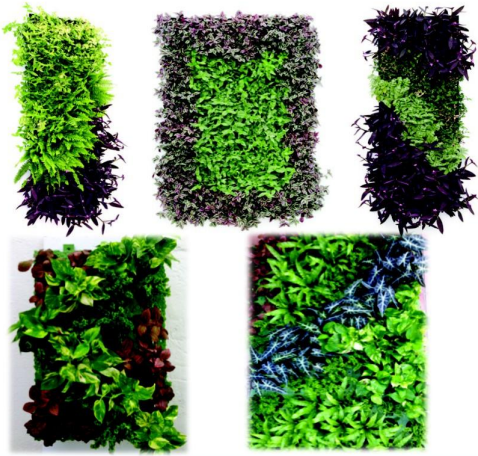

植物綠牆

Green Wall

中型



小型



大型





Green Wall

植物綠牆系列



1. walls
綠牆寶

2. Non-Soil Green Wall
無土植物牆

3. Natural Green Wall
水種綠牆

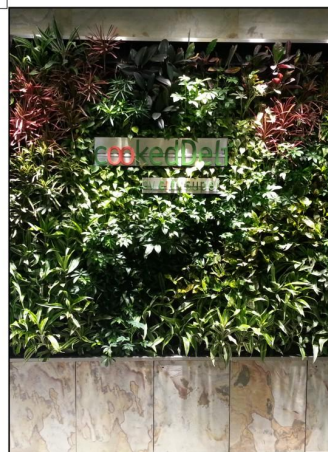
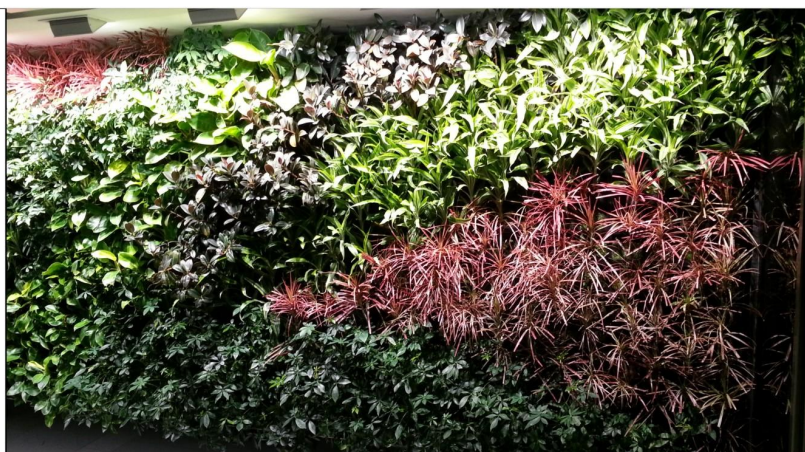
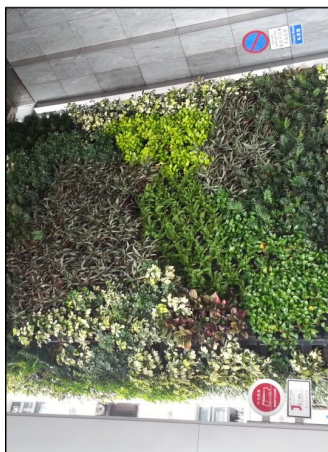

Structural Design

walls 綠牆寶



Large (L)

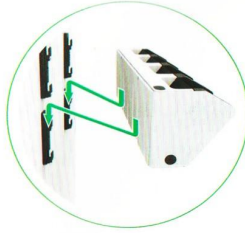

Hook Design
簡易掛鉤



Separate Inner Design
獨立內盆



Self Watering
自動灌溉



Stopper
排水活塞



Light and Durable
輕巧耐用

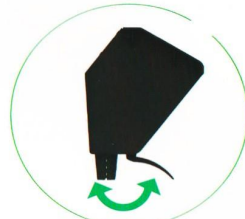

Foldable stand
直力腳



Water level Indicator
水位顯示器

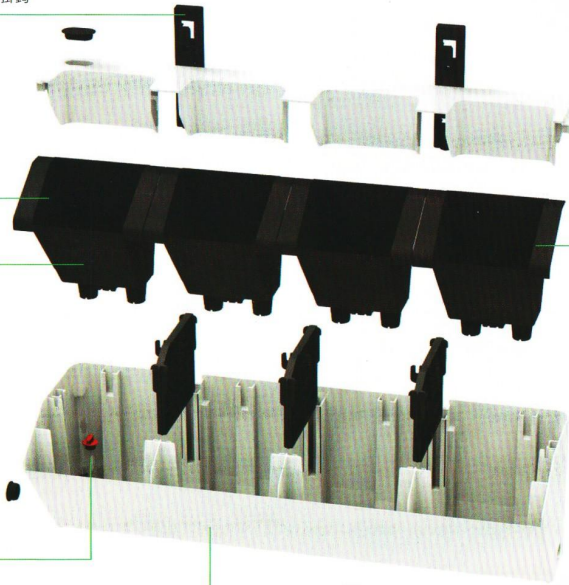

Walls



W	D	H	I	V
57	18	18	10	0.8
———— (cm) ————				(L)

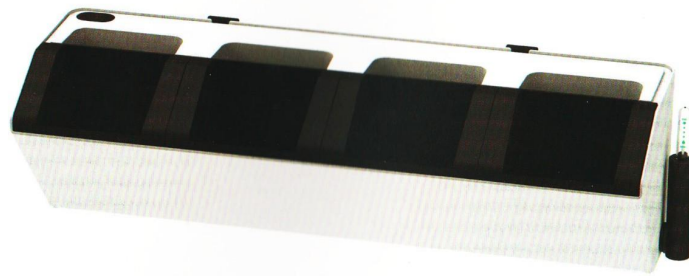

Planter Body 	Cover 	Partitions 	Pods 	Water Level Indicator 	Connector Assembly
Mounting Brackets 	Side Plugs 	Top Stopper 	Internal Stopper (red) 	Body Stand 	Screws M4.5 x 50mm Wall Plugs 8mm x 30mm

Features

walls 綠牆寶



Shaft Design

Remove the top stopper and slowly fill the reservoir.
(Approximate weight of single planter when full: 6.8 kg)
打開頂部活塞，慢慢地加水。
(每個使用中的植物的重量平均達6.8kg)



Water level Indicator

The water level indicator stem should rise as the water level rises. Stop watering when the indicator reaches FULL.
水位顯示器隨著水位而上升，一直加水到浮標到達“FULL”為止

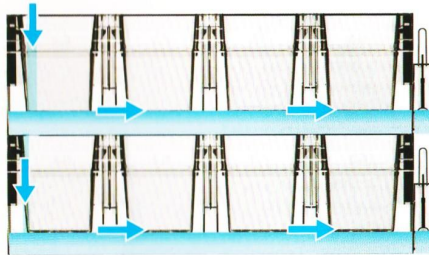

Water Flow System

Walls water flow system circulates throughout no matter how many vertical gardens you connect, all the time nourishing your plants.
無論連接了多少個植物牆，也能平均地滋養植物。



Stopper

If the product was located where is susceptible to frequent rainfall, we recommend removing the red stopper on the last planter, as illustrated above, to prevent the unit from overflowing.
如在戶外使用，請打開最後一層的紅色活塞，過剩的雨水會自動流出

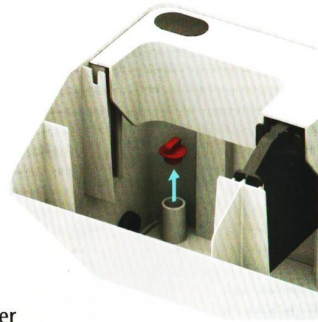

Body Stand

Two additional base can help the planter stand alone on the floor, table or windowsill.
主體在種植物後重心會傾前，增加兩個底座，這樣主體加上植物時重心就不會傾前了。

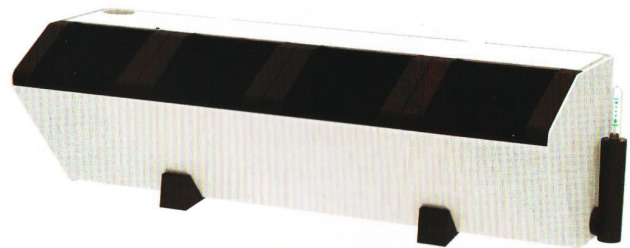

Installation

Designed for use in vertical gardening and Green Wall. The product can be stand-alone or connected horizontally and vertically to form a "vertical garden".
綠牆寶植物牆可以獨立使用，或連接起來構成一幅垂直花園。

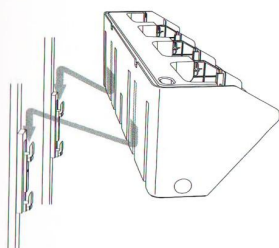
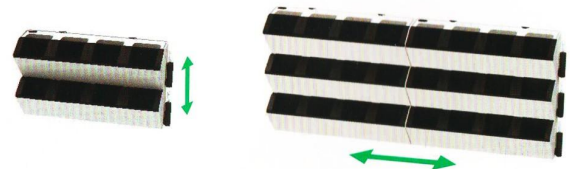

(A) On Rack
上架

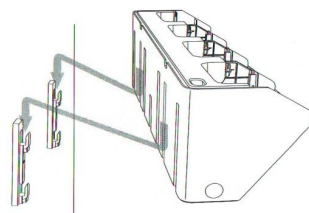

(B) On Wall
上牆

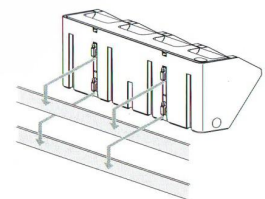

(C) On Bar
欄杆

Walls +

walls 綠牆寶

Inner / 內盆

With new security clip design, it can prevent strong winds or any unnecessary disturb. To remove the inner from the planter just simply press the security clip before removing.

內盆新增加安全扣片設計，可預防戶外強風或途人隨意提取。取出時先把安全扣片按下方可取出內盆。

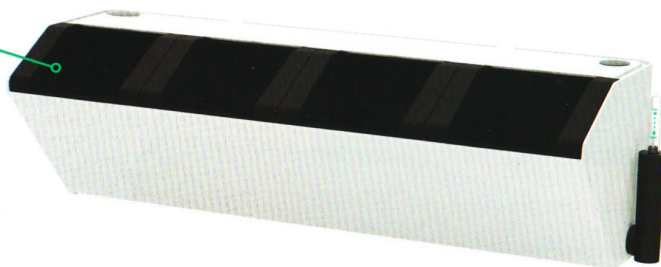

Reservoir Cover / 儲水層蓋板

When used with the electric water pump, the bottom planter will need to become a reservoir for the system, so it can prevent mosquito.

當配合電水泵使用時，最底層的主體需改成水箱用途，所以要加儲水層蓋板來預防蚊蟲。

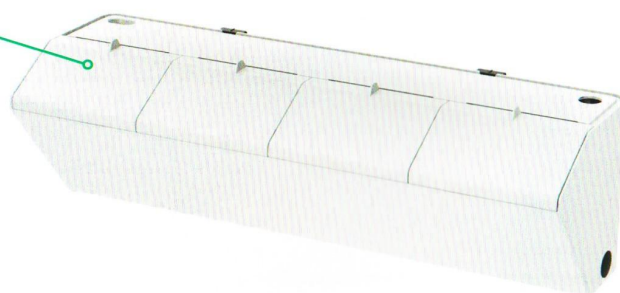

Bracket / 掛鉤

The new design bracket is more user-friendly to install, even the drilling had not been done very well.

新設計的主體掛鉤更便用戶安裝，不會導致鑽孔有偏差時裝不上主體的情況。

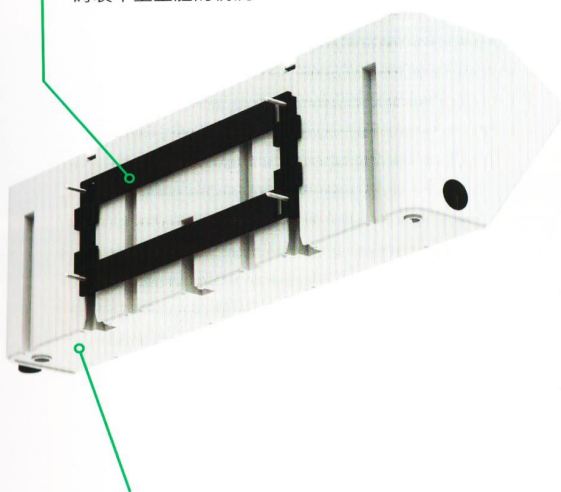

Body / 主體

Built-in dual water pipe hole design; The purpose is to increase the water flow, less chance to block the planter. Users now can also setup a electric water pump into the system.

內置雙管道流水設計，目的是增加水流量，還可以減低植物牆堵塞的機會。用戶更可在新改良的主體內在增加電水泵，達到真正的水循環效果。



Walls and Walls+
Summary

walls 綠牆寶

Walls

W	D	H	NW
57	18	18	1.4
— (cm) —		(kg)	



1 Unit Single Set 單裝



2 Units Combo Set 孖裝



Matte Black
AW5718-W07M
AW5736-W07M



Lime
AW5718-W03M
AW5736-W03M

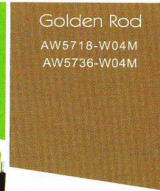

Golden Rod
AW5718-W04M
AW5736-W04M



Ivory
AW5718-W05M
AW5736-W05M



Dim Silver
AW5718-W06M
AW5736-W06M

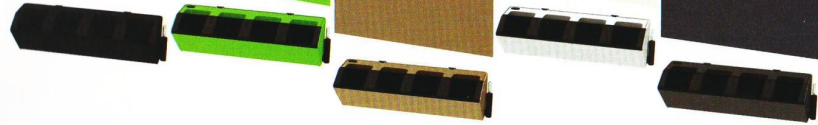

Walls +

W	D	H	NW
57	18	36	1.4
— (cm) —		(kg)	



Body Set

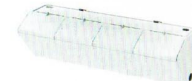

Water Tank



Matte Black
AWP5718-W07M
AWPVAT-W07M



Lime
AWP5718-W03M
AWPVAT-W03M

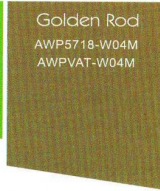

Golden Rod
AWP5718-W04M
AWPVAT-W04M

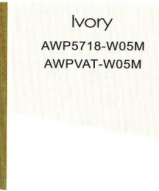

Ivory
AWP5718-W05M
AWPVAT-W05M

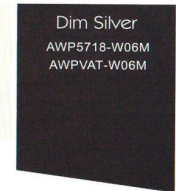

Dim Silver
AWP5718-W06M
AWPVAT-W06M

Walls Rack

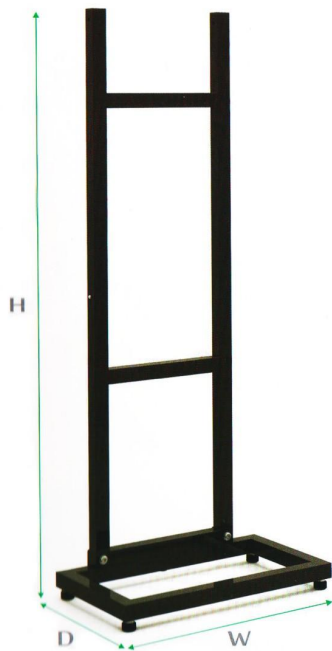

AGWA13-00

W	D	H	NW
45	25.5	114.6	3.5
— (cm) —		(kg)	

Walls Additional Rack

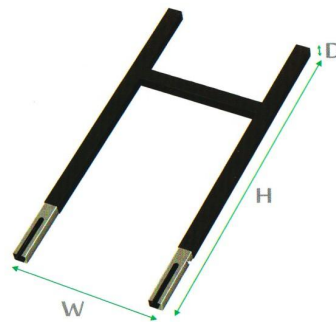

AGWA14-00

W	D	H	NW
31	2.8	66.8	1.15
— (cm) —		(kg)	

Walls Rack

Don't want to drill holes on your wall?
Walls Rack can solve the problem. A single Rack
can hang maximum 6 sets of Walls.

不想在牆上鑽孔？不用擔心，綠牆寶植物牆
掛架基本套裝最多可懸掛6層綠牆寶。

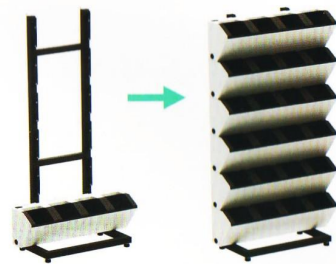

Walls Additional Rack

Extension part of Rack. It allow
you to add extra 3 sets of
HydroFalls on top.
We recommend not to install
more than 12 planter units
vertically.

綠牆寶植物牆掛架的獨立
加高配件，每套可額外懸
掛3層植物牆。
我們建議總高度不要超過
12層。



日本植物緑牆 Non-Soil Green Wall

1. CABINET (循環水系統) 無土植物牆

壁面緑化 花のかべ

材質について

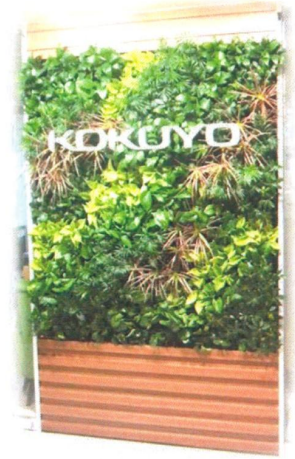
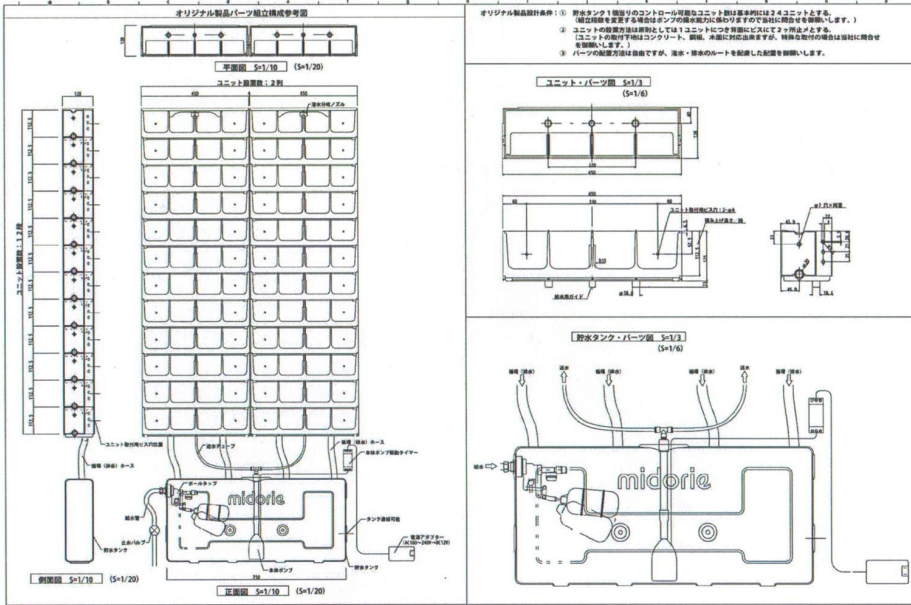

日本植物緑牆

2. WALL

壁面緑化 花のかべ

材質について

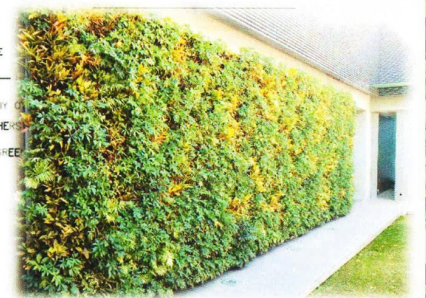
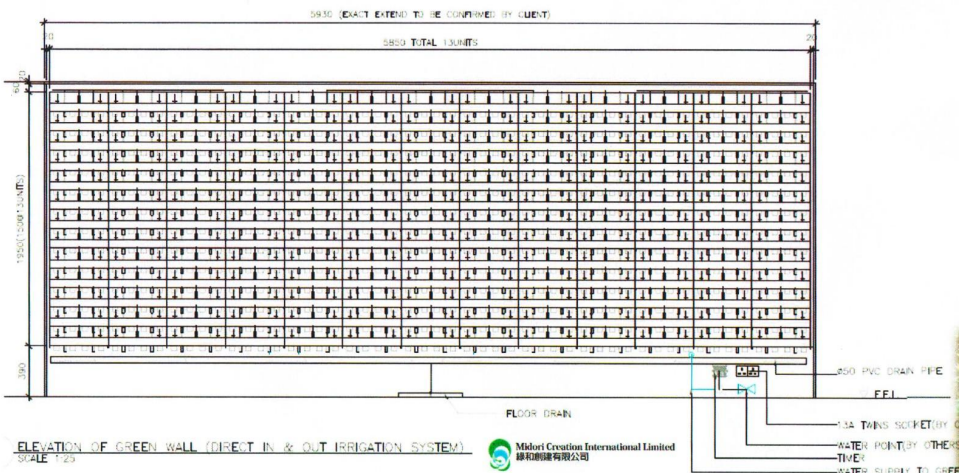

1. Cabinet 循環水綠化牆

Non-Soil Green Wall
無土植物牆



-需要: 1.來水, 2.光 及 3.電

2. Wall 綠化牆

-需要: 1.來水, 2.光 + 3.去水 及 4.電



為家居製造一個室內小型花園
- 一個舒適, 請身心得到真正休息的家



好處

Non-Soil Green Wall 無土植物牆

- 自動灌溉系統, 打理方便。
- 系統設計供室內/ 室外使用。
- 日本全新科技, 無土植物, 更易打理及乾淨。
- 產品及系統的獨特性, 不會有積水; 在正確打理下, 不會有蚊蟲滋生。
- 一站式服務, 由睇位, 設計及保養上, 還有專人教導種植。
- 為家居製造一個室內小型花園, 淨化空氣; 一個五星級的家。



Natural Green Wall 水種綠牆

人工綠牆

耐用性及持久性

- 通過老化測試
- 通過抗UV測試
- 通過恆溫蒸氣測試
- 通過衝擊測試

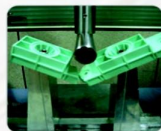

產品及服務

諮詢

提供免費的報價及諮詢服務，了解客人需要及心中的設計概念，確保整個過程中客人的需要是被放在首位。

設計

派員進行上門服務去量度位置呎吋、採光度、灌溉喉管接駁方法。另外、會提供設計草稿以及綠牆切步效果圖，讓顧客對綠牆的整體設計。

選擇植物

我們會根據植物的尺寸，形狀、生長速度、受水性和光照需求，提供適合的植物品種以打造獨一無二的綠牆。

組裝

- 第一步：設置防水層
- 第二步：綠牆主體裝嵌
- 第三步：安裝自動灌溉系統
- 第四步：根據預先設計圖形放入植物

保養及售後服務：

提供三個月的免費保養服務，包括植物健康狀態評估、除草、施肥、滅蟲以及作出植物更換，提供修剪以固定設計圖案，更換生長不良的植物。



Natural Green Wall 水種綠牆

什麼是人工綠牆?

人工綠牆是植物學, 工程技術以及藝術表現三者結合的一個綜合產物。

人工垂直綠化又稱為垂直花園以及植物綠牆, 既適用於室內也適用於戶外環境。通過安裝環保再生種植裝置, 把植物紮根於主體盤中, 採用無土生長介質, 進行垂直綠化。透過自動灌溉系統或自控式澆水, 為你輕鬆打造城市裡的綠洲。

環保再生種植裝置

- 即時綠化效果
- 多種植物選擇
- 無空間限制
- 方便打理
- 容易安裝

*由日本smile 公司設計, 台灣環保再生塑膠物料製造

人工綠牆的好處:

環境

- 氣質素
- 平衡空氣濕度
- 減低室溫

提升企業形象

根據研究顯示, 綠牆及其他綠化項目可以為消費者帶來正面及安全的形象, 人工垂直綠化和植物帶, 能夠將住宅和商業地帶的價值提升7-15%!

社會效益

提供綠色視野, 讓久居都市的人們可更接近大自然, 緩解日常生活壓力。

節能效益

降低室內溫度3至7度, 將每個月的用電賬單減少近20%。

人工綠牆

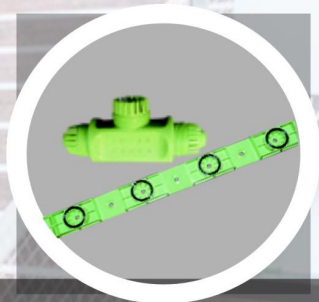
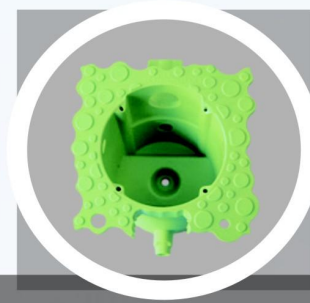

工程實例 Job Reference

